

TS2000VA Type:

Single-phase 2000VA toroidal transformers, manufactured and tested in compliance with EN 61558.

Designed and prepared for II class equipment. Suited for power supply circuitry of electric machines and electronic devices with low non-load losses and weight.

Transformers can be customized into several desired dimensions and voltage taps on both primary and secondary sides. Transformer can be also equipped with the following features:

- electrical and electromagnetic shield,
- thermal protection switch,
- plastic, metal and DIN rail mounting
- soft-start system,
- interior epoxy filling.

Technical specification:

Nominal Power: 2000VA
 Input voltage: 1 – 500V
 Frequency: 50 – 60Hz
 Output voltage: 1 – 1000V (multiple taps)

Construction / Insulation class: II / B (130°C)
 Ambient temperature: 40°C
 Protection degree: IP-00
 Insulation voltage test: 4kVAC (RMS)

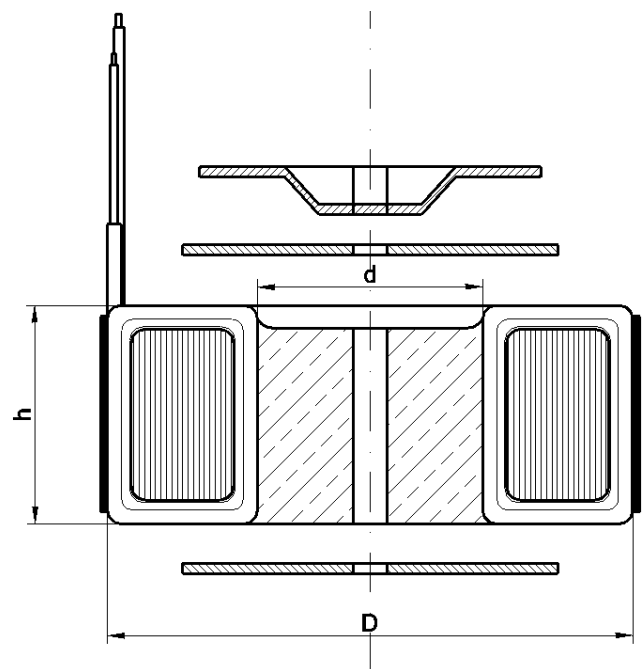

DIMENSIONS

Outer diameter (D): 187mm
 Inner diameter (d): 60mm
 Height (h): 69mm
 Weight: 9,8 kg
 Leads lenght: as needed

Wiring diagram:

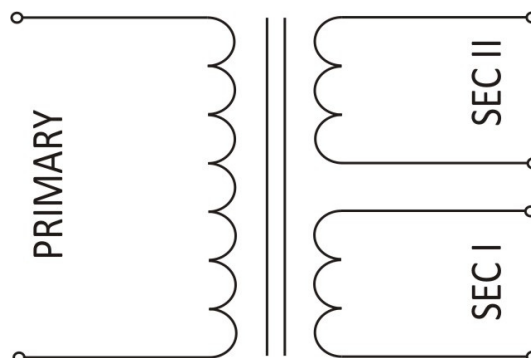

example, double secondary transformer – can be used series or parallel connected.

Standard models:

Type	SECONDARY I voltage [VAC]	SECONDARY II voltage [VAC]	SECONDARY I current [A]	SECONDARY II current [A]
TS2000VA 230/12V	12	---	166,67	---
TS2000VA 230/14V	14	---	142,86	---
TS2000VA 230/16V	16	---	125,00	---
TS2000VA 230/17V	17	---	117,65	---
TS2000VA 230/18V	18	---	111,11	---
TS2000VA 230/20V	20	---	100,00	---
TS2000VA 230/22V	22	---	90,91	---
TS2000VA 230/24V	24	---	83,33	---
TS2000VA 230/28V	28	---	71,43	---
TS2000VA 230/32V	32	---	62,50	---
TS2000VA 230/35V	35	---	57,14	---
TS2000VA 230/40V	40	---	50,00	---
TS2000VA 230/45V	45	---	44,44	---
TS2000VA 230/50V	50	---	40,00	---
TS2000VA 230/60V	60	---	33,33	---
TS2000VA 230/70V	70	---	28,57	---
TS2000VA 230/80V	80	---	25,00	---
TS2000VA 230/90V	90	---	22,22	---
TS2000VA 230/2x12V	12	12	83,33	83,33
TS2000VA 230/2x14V	14	14	71,43	71,43
TS2000VA 230/2x16V	16	16	62,50	62,50
TS2000VA 230/2x17V	17	17	58,82	58,82
TS2000VA 230/2x18V	18	18	55,56	55,56
TS2000VA 230/2x20V	20	20	50,00	50,00
TS2000VA 230/2x22V	22	22	45,45	45,45
TS2000VA 230/2x24V	24	24	41,67	41,67
TS2000VA 230/2x28V	28	28	35,71	35,71
TS2000VA 230/2x32V	32	32	31,25	31,25
TS2000VA 230/2x35V	35	35	28,57	28,57
TS2000VA 230/2x40V	40	40	25,00	25,00
TS2000VA 230/2x45V	45	45	22,22	22,22
TS2000VA 230/2x50V	50	50	20,00	20,00
TS2000VA 230/2x60V	60	60	16,67	16,67
TS2000VA 230/2x70V	70	70	14,29	14,29
TS2000VA 230/2x80V	80	80	12,50	12,50
TS2000VA 230/2x90V	90	90	11,11	11,11