

TS50VA Type:

Single-phase 50VA toroidal transformers, manufactured and tested in compliance with EN 61558.

Designed and prepared for II class equipment. Suited for power supply circuitry of electric machines and electronic devices with low non-load losses and weight.

Transformers can be customized into several desired dimensions and voltage taps on both primary and secondary sides. Transformer can be also equipped with the following features:

- electrical and electromagnetic shield,
- thermal protection switch,
- plastic, metal and DIN rail mounting
- soft-start system,
- interior epoxy filling.

Technical specification:

Nominal Power: 50VA
 Input voltage: 1 – 500V
 Frequency: 50 – 60Hz
 Output voltage: 1 – 1000V (multiple taps)

Construction / Insulation class: II / B (130°C)
 Ambient temperature: 40°C
 Protection degree: IP-00
 Insulation voltage test: 4kVAC (RMS)

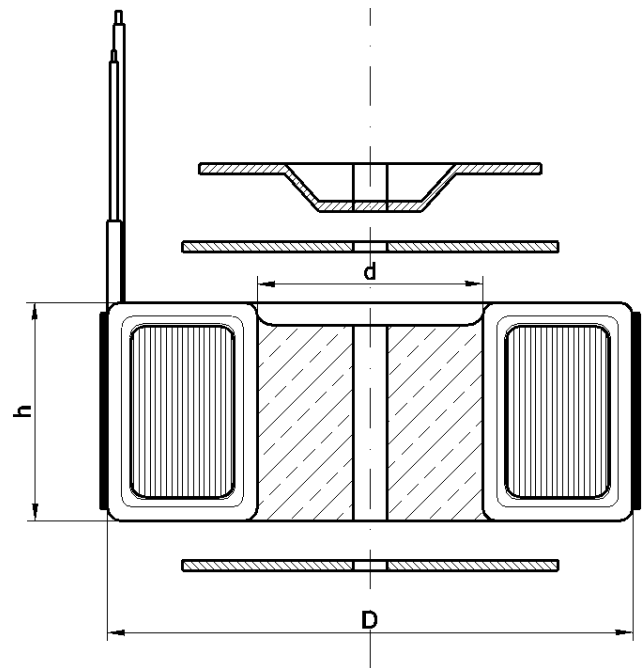

DIMENSIONS

Outer diameter (D):	78mm
Inner diameter (d):	32mm
Height (h):	31mm
Weight:	0,7 kg
Leads lenght:	as needed

Wiring diagram:

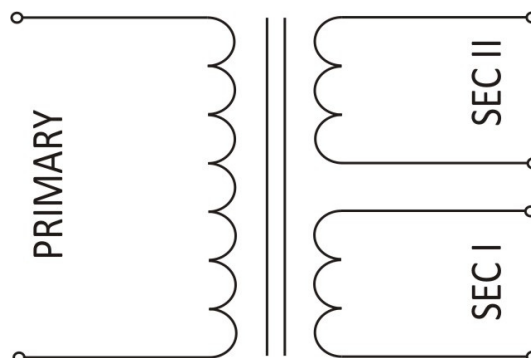

example, double secondary transformer – can be used series or parallel connected.

Standard models:

Type	SECONDARY I voltage [VAC]	SECONDARY II voltage [VAC]	SECONDARY I current [A]	SECONDARY II current [A]
TS50VA 230/10V	10	---	5,00	---
TS50VA 230/12V	12	---	4,17	---
TS50VA 230/14V	14	---	3,57	---
TS50VA 230/16V	16	---	3,13	---
TS50VA 230/17V	17	---	2,94	---
TS50VA 230/18V	18	---	2,78	---
TS50VA 230/20V	20	---	2,50	---
TS50VA 230/22V	22	---	2,27	---
TS50VA 230/24V	24	---	2,08	---
TS50VA 230/28V	28	---	1,79	---
TS50VA 230/32V	32	---	1,56	---
TS50VA 230/35V	35	---	1,43	---
TS50VA 230/40V	40	---	1,25	---
TS50VA 230/45V	45	---	1,11	---
TS50VA 230/50V	50	---	1,00	---
TS50VA 230/60V	60	---	0,83	---
TS50VA 230/70V	70	---	0,71	---
TS50VA 230/80V	80	---	0,63	---
TS50VA 230/90V	90	---	0,56	---
TS50VA 230/2x10V	10	10	2,50	2,50
TS50VA 230/2x12V	12	12	2,08	2,08
TS50VA 230/2x14V	14	14	1,79	1,79
TS50VA 230/2x16V	16	16	1,56	1,56
TS50VA 230/2x17V	17	17	1,47	1,47
TS50VA 230/2x18V	18	18	1,39	1,39
TS50VA 230/2x20V	20	20	1,25	1,25
TS50VA 230/2x22V	22	22	1,14	1,14
TS50VA 230/2x24V	24	24	1,04	1,04
TS50VA 230/2x28V	28	28	0,89	0,89
TS50VA 230/2x32V	32	32	0,78	0,78
TS50VA 230/2x35V	35	35	0,71	0,71
TS50VA 230/2x40V	40	40	0,63	0,63
TS50VA 230/2x45V	45	45	0,56	0,56
TS50VA 230/2x50V	50	50	0,50	0,50
TS50VA 230/2x60V	60	60	0,42	0,42
TS50VA 230/2x70V	70	70	0,36	0,36
TS50VA 230/2x80V	80	80	0,31	0,31
TS50VA 230/2x90V	90	90	0,28	0,28